

Article number: 20196B25B252SW

Description: E+G Angle connector clamp
GN 196-B25-B25-2-SW

Measures

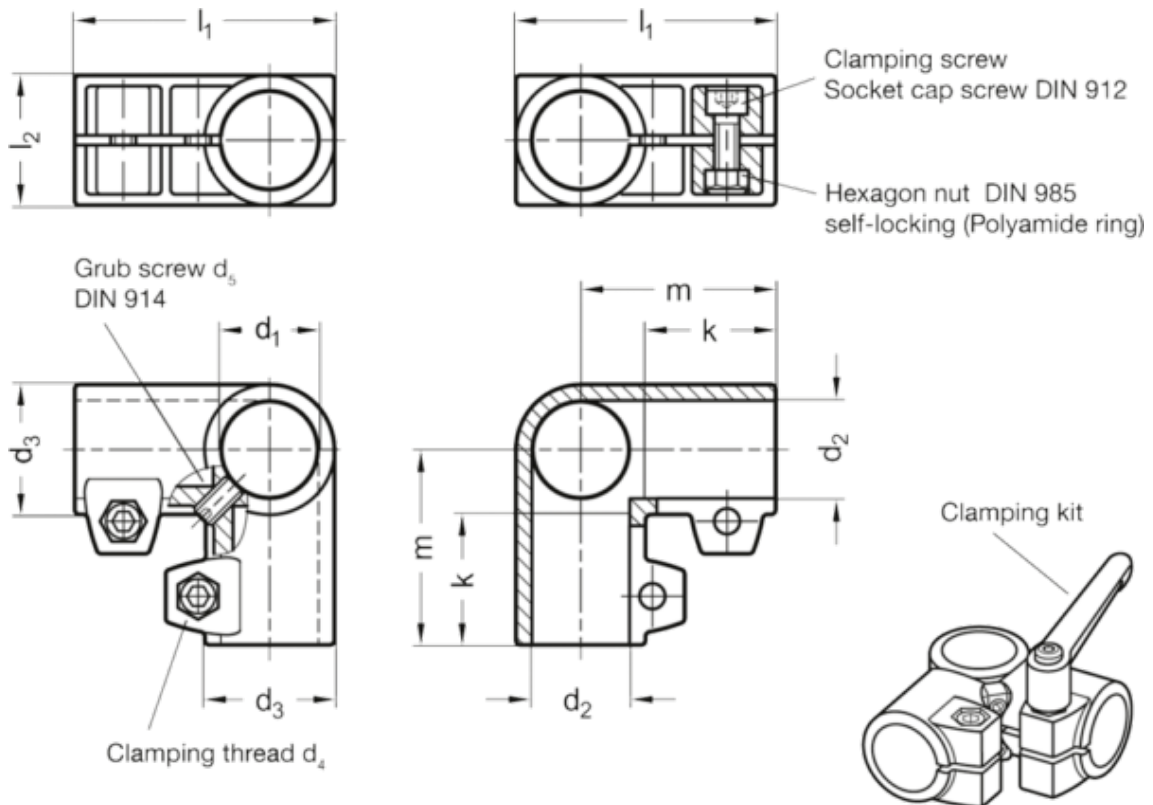

	= 287
Clamping kits for d4 = GN 911-M8-32	
d2	= B 25
d3	= 40
d4	= M 8
d5	= M 8
l1	= 80
l2	= 52

k Clamping length	= 40
m	= 60
Weight in (g)	= B 25